



JIANGSU HOSTON MACHINE TOOLS CO., LTD.

江苏豪士敦机械设备有限公司

Mob: 0086-18021995133 Tel: 0085-523-84506989

Email: sales@hoston.cc Website: www.hostonspinning.com

CNC Metal Spinning Machine

(WLH-DRS650 heavy-duty double rollers slant bed style)



(WLH-Series)

QUOTATION

Date: 2023-01-11



JIANGSU HOSTON MACHINE TOOLS CO., LTD.

江苏豪士敦机械设备有限公司

Mob: 0086-18021995133 Tel: 0085-523-84506989

Email: sales@hoston.cc Website: www.hostonspinning.com

I. Company Introduction

Our company was founded in 1999 with 20 years of experience in metal spinning technology. We are located in Guangzhou city, Guangdong Province, which is adjacent to Guangzhou Baiyun and Hong Kong international airport. We are a national high-tech enterprise authenticated by the ISO9001:2019, CE, and also a professional CNC metal spinning machine manufacturing company in China, integrating scientific-research, manufacturing, sales, customer services and education in one. We add value to the entire product life-cycle, and we can offer and the required know-how and technology from the initial idea through development and prototyping to ongoing production and offer the high-quality spinning machine to meet customer product's requirements. After 2 decades of unremitting efforts, now HOSTON becomes the Top-rank CNC metal spinning manufacturer in China.





JIANGSU HOSTON MACHINE TOOLS CO., LTD.

江苏豪士敦机械设备有限公司

Mob: 0086-18021995133 Tel: 0085-523-84506989

Email: sales@hoston.cc Website: www.hostonspinning.com

HOSTON also develops advanced control systems, and provides users with automatic programming operation software to provide users with personalized customization and all process support.

HOSTON has been committing to helping customers solve difficulties offering turnkey project both machine and technical solutions to customer, bringing convenience to customers with the most economical price and the most accurate solution.



II. Machines Introduction

1. Functions

TECHNOLOGIES

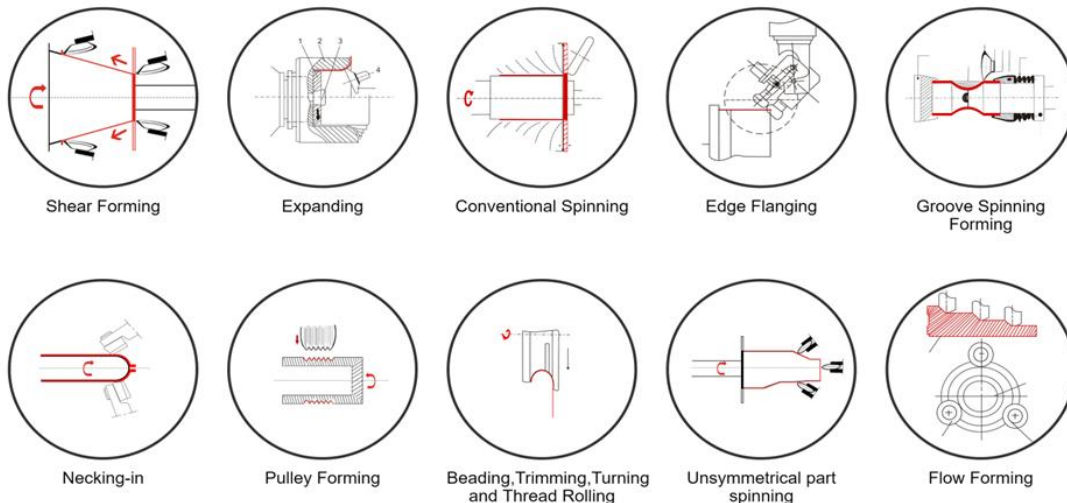



JIANGSU HOSTON MACHINE TOOLS CO., LTD.

江苏豪士敦机械设备有限公司

Mob: 0086-18021995133 Tel: 0085-523-84506989

Email: sales@hoston.cc Website: www.hostonspinning.com

2. Purposes



WLH-DRS series CNC Spinning and Turning Machine (Double Rollers) is especially developed to spin kitchen-wares, lamps, auto fittings, ventilation and art wares. It has many patents issued by the State Intellectual Property Office. This machine is practical, professional and strong. It has high production efficiency and can complete horn, bucket, cone type, parabolic products.

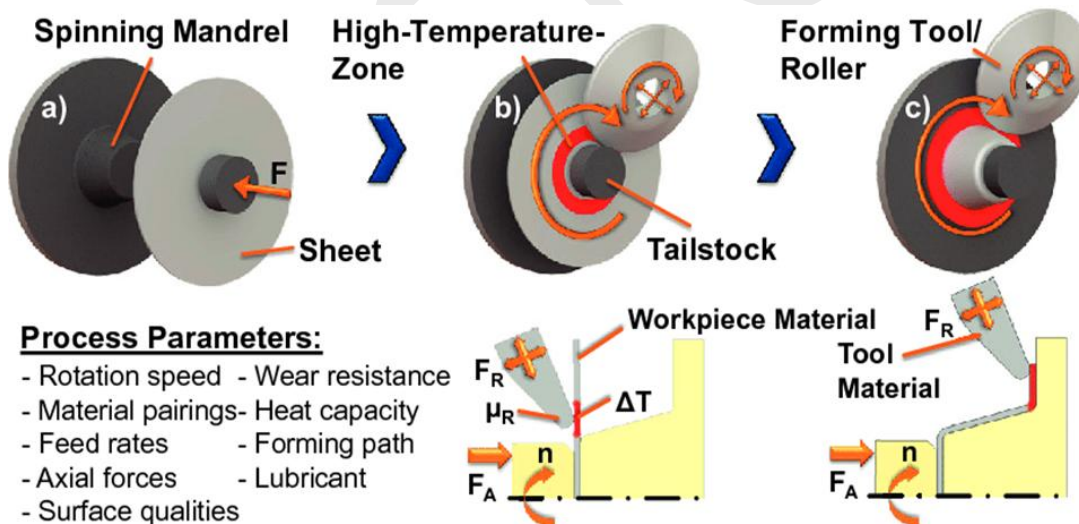

It can also process threading, trimming, flanging and rolling at the same machine tool. The machine can spin many materials such as carbon steel, stainless steel, aluminum and copper etc. It has solved the traditional problems such as lack of skilled workers. With advanced digital control, it is easy to operate.



JIANGSU HOSTON MACHINE TOOLS CO., LTD.

江苏豪士敦机械设备有限公司

Mob: 0086-18021995133 Tel: 0085-523-84506989

Email: sales@hoston.cc Website: www.hostonspinning.com

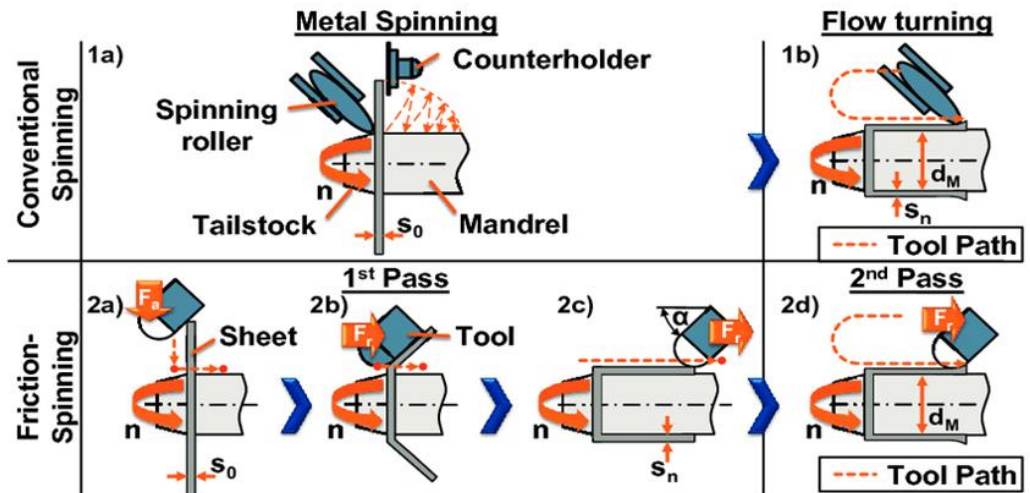

The machine can improve the production efficiency, machining accuracy and saving the cost of human resources. It is the ideal processing machine for light, automobile, military, mechanic and other manufacturing industries.

3. Controller Options

Item	Photos	Features:
SIEMENS 808D		<ul style="list-style-type: none"> Up to 3 axes/spindles Interpolating Axes: up to 3 Pulse and direction interface to drive Canned cycle programming Drive & Motors 1 Machining Channel 200% overload



JIANGSU HOSTON MACHINE TOOLS CO., LTD.



江苏豪士敦机械设备有限公司

Mob: 0086-18021995133 Tel: 0085-523-84506989

Email: sales@hoston.cc Website: www.hostonspinning.com

<p>SIEMENS 828D</p>		<ul style="list-style-type: none"> Up to 4 axes/spindles Interpolating Axes: up to 4 Drive bus communication Conversational programming available Drive & Motors 2 Machining Channels 300% overload
<p>SIEMENS 840DSL</p>		<ul style="list-style-type: none"> Up to 93 axes/spindles Interpolating Axes: up to 5 30 Machining Channels Motor torque: 3.5-170Nm Up to 25" touch display 1500 tools, 3000 cutting edges

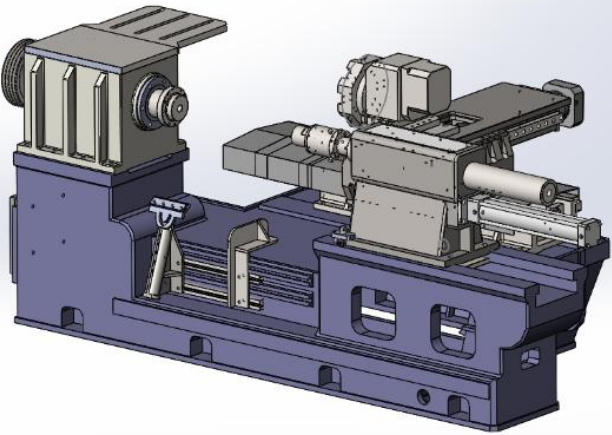
4. Machine structure (Heavy-duty WLH-series) –Casted Iron Structure

<p>Horizontal bed style (Raw material $\geq 1000\text{mm}$)</p>	<p>Slant bend style (Raw material $\leq 800\text{mm}$)</p>
	



JIANGSU HOSTON MACHINE TOOLS CO., LTD.

江苏豪士敦机械设备有限公司

Mob: 0086-18021995133 Tel: 0085-523-84506989

Email: sales@hoston.cc Website: www.hostonspinning.com

5. Standard Configuration & Main Features

- * **Siemens controller** as standard CNC system which has USB port.
- * Mechanize cast iron after aging treatment, with high quality and less deformation.
- * Adopted independent spindle unit to ensure good movement precision, stiffness and stability.
- * Precision ball screws ensure dynamic performance well and positioning accurately.
- * X axis adopts integral two-way ball screw, 2 rollers move in synchronization.
- * Feeding axles are driven by servo motors.
- * Spindle motor is Servo controlled.
- * Hydraulic tail-stock. Mobile and clamp by hydraulic system.
- * Integrated automatic lubrication system makes the maintenance more reliable.
- * Configuration cooling pump.
- * Mobile manual pulse generator makes easy to operate.
- * Full/semi-enclosed shield.

6. Technical Parameter

No.	Model	WLH-DRS650
1	Amount of Rollers	Sync 2+
2	Max. Diameter of Material	Ø650 mm
3	Max. distance between upper roller and bottom roller	650mm
4	Max. Length of Work Piece	430m
5	Thickness of Work Piece	0.5-5.0 mm (Aluminum, Copper) 0.5-3.0 mm (Carbon Steel) 0.5-2.0 mm (Stainless Steel)
6	X Travel	650mm
7	Z Travel	450mm



JIANGSU HOSTON MACHINE TOOLS CO., LTD.

江苏豪士敦机械设备有限公司

Mob: 0086-18021995133 Tel: 0085-523-84506989

Email: sales@hoston.cc Website: www.hostonspinning.com

8	Spindle Speed (Stepless)	2000rpm
9	Spindle	A2-5
10	Max. Tail Force	25KN
11	Travel of Tailstock	500mm
12	Travel of Tailstock Quill	300mm
13	Amount of Tools	4+4/*6+6/*8+8
14	Main Motor Power	18.5KW Servo
15	Hydraulic Station Motor Power	2.2KW

Note:

1. The final explanation right of all parameters, values and technical descriptions is reserved by Hoston Machine Tools.
2. The processing capacity listed in Item No. 5 should be matched with relevant product drawings and confirmed by both parties finally.

7. Machine details

No.	Item	Photo
1	Machine Appearance	 <p>Full-cover protection door(standard) *Auto- door with Anti-pinch function (Optional)</p>





JIANGSU HOSTON MACHINE TOOLS CO., LTD.

江苏豪士敦机械设备有限公司

Mob: 0086-18021995133 Tel: 0085-523-84506989

Email: sales@hoston.cc Website: www.hostonspinning.com

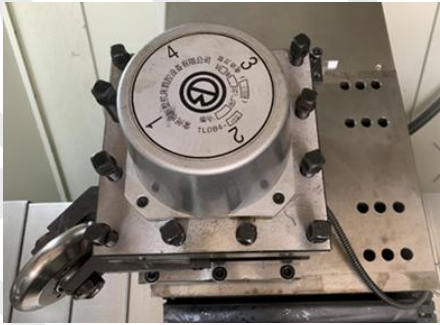
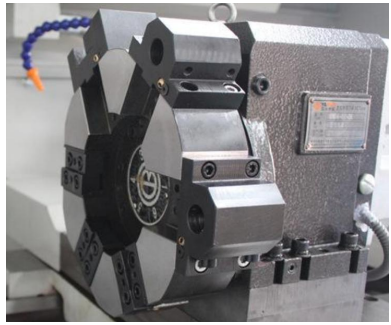
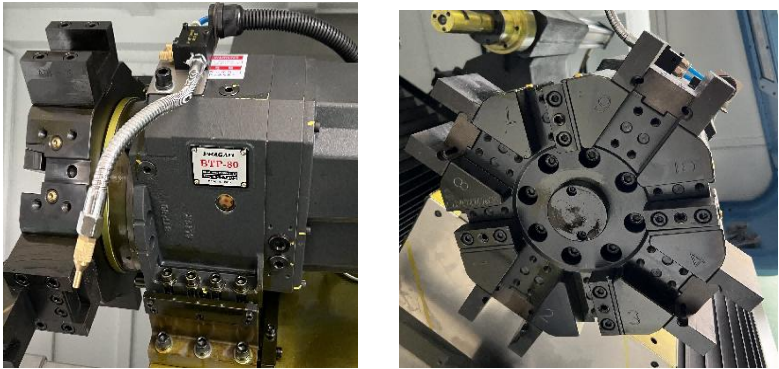
2	CNC Controller (Optional)	 <p>*Siemens 808D</p>	 <p>*Siemens 828D</p>
3	Hydraulic station		
4	Tool post	 <p>4+4-position tool post (standard)</p>	 <p>*6+6-position tool post (Optional)</p>
	Tool post	 <p>*8+8 position servo drive CW/CCW tool post</p>	





JIANGSU HOSTON MACHINE TOOLS CO., LTD.

江苏豪士敦机械设备有限公司

Mob: 0086-18021995133 Tel: 0085-523-84506989

Email: sales@hoston.cc Website: www.hostonspinning.com

		(Optional)
5	Moulds (mandrel) *(Optional)	
6	Adaptor (A2-5)	



JIANGSU HOSTON MACHINE TOOLS CO., LTD.

江苏豪士敦机械设备有限公司

Mob: 0086-18021995133 Tel: 0085-523-84506989

Email: sales@hoston.cc Website: www.hostonspinning.com

7

Lubrication system



8

Servo motor

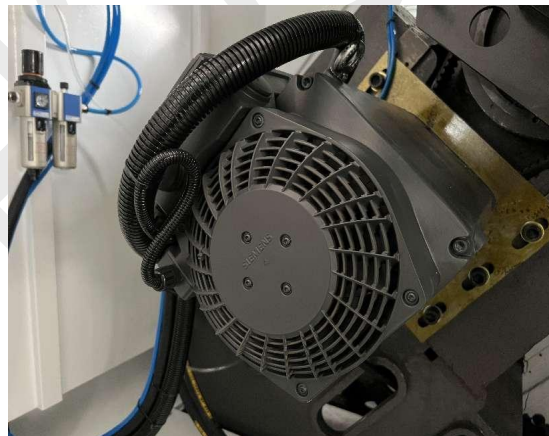

***SIEMENS (Optional)**





JIANGSU HOSTON MACHINE TOOLS CO., LTD.

江苏豪士敦机械设备有限公司

Mob: 0086-18021995133 Tel: 0085-523-84506989

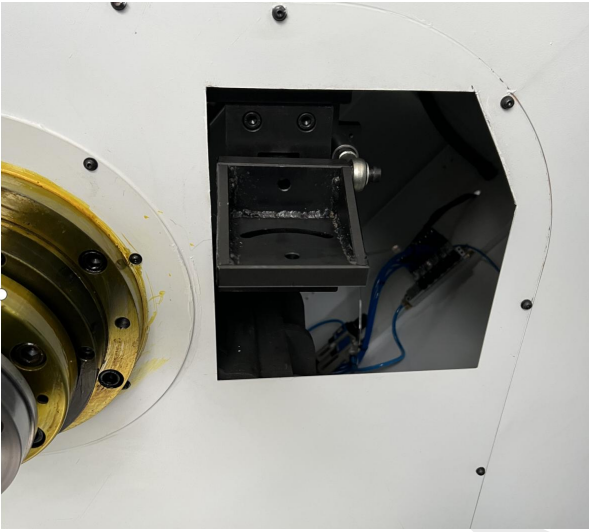
Email: sales@hoston.cc Website: www.hostonspinning.com

9	Hydraulic Hold plate	 <p>*(Optional)</p>
10	Ejector	 <p>Pneumatic (standard)</p>
		 <p>*Hydraulic (Optional)</p>



JIANGSU HOSTON MACHINE TOOLS CO., LTD.

江苏豪士敦机械设备有限公司

Mob: 0086-18021995133 Tel: 0085-523-84506989

Email: sales@hoston.cc Website: www.hostonspinning.com

11	Roller & Holder	
12	Oil split unit	 <p>*(Optional)</p>
13	Oil mist collector	 <p>*(Optional)</p>





JIANGSU HOSTON MACHINE TOOLS CO., LTD.

江苏豪士敦机械设备有限公司

Mob: 0086-18021995133 Tel: 0085-523-84506989

Email: sales@hoston.cc Website: www.hostonspinning.com

14	Chip conveyor	 <p>*(Optional)</p>
15	Electrical cooling system	 <p>*(Optional)</p>
16	Blank centering device(material support)	 <p>*(Optional)</p>



JIANGSU HOSTON MACHINE TOOLS CO., LTD.

江苏豪士敦机械设备有限公司

Mob: 0086-18021995133 Tel: 0085-523-84506989

Email: sales@hoston.cc Website: www.hostonspinning.com

17 Package



https://www.youtube.com/watch?v=_gOusLHZHMq&t=44s

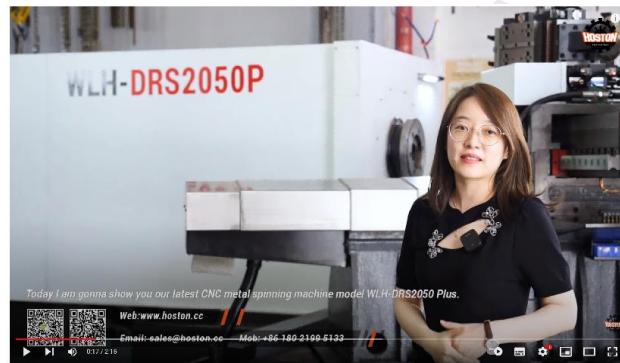

18 Related video

(WLH-DRS2050P Flared type)

<https://www.youtube.com/watch?v=OOeEhyg-RJ4>



(WLH-DRS1250 Horizontal type)



JIANGSU HOSTON MACHINE TOOLS CO., LTD.

江苏豪士敦机械设备有限公司

Mob: 0086-18021995133 Tel: 0085-523-84506989

Email: sales@hoston.cc Website: www.hostonspinning.com

<https://www.youtube.com/watch?v=hln3mgIKnE8>



Hoston CNC Metal Spinning Machine WLH-DRS1050 Металл Прядильная машина с ЧПУ

Hoston Spinning

496次观看 · 1天前
Cation CNC Metal Spinning Machine WLH-DRS1050
Металл | Прядильная машина с ЧПУ
#hostonmachine #CNC

(WLH-DRS 1050 Horizontal type)

<https://www.youtube.com/watch?v=dLr7FTDUpX8>



Metal Spinning Machine Hoston Model WLH-DRS850 | metal spinning cnc process | metal spun forming machine

Hoston Spinning

127次观看 · 8个月前
CNC metal spinning lathe machine form HOSTON have the most advanced metal spinning and metal processing technology. Our R & D department focuses on the development of metal forming technology. All metal spinning lathe machine are carefully designed and built, high quality automatic metal spinning process is what our machines are good at. Metal spun, flow forming, shear forming, pipe spinning, tube spinning, wheel rim flow forming, and many other technologies, can meet your various metal processing and metal forming needs. 展开

(WLH-DRS850 slant bed type)

https://www.youtube.com/watch?v=s2U6wrksN_g



Metal Spinning Lathe Machine | metal spun | metal spinning cnc | flow forming machine | spinning process

Hoston Spinning

240次观看 · 9个月前
CNC metal spinning lathe machine form HOSTON have the most advanced metal spinning and metal processing technology. Our R & D department focuses on the development of metal forming technology. All metal spinning lathe machine are carefully designed and built, high quality automatic metal spinning process is what our machines are good at. Metal spun, flow forming, shear forming, pipe spinning, tube spinning, wheel rim flow forming, and many other technologies, can meet your various metal processing and metal forming needs. 展开

(WLH-DRS650 slant bed type)

<https://www.youtube.com/watch?v=8cm6nYTLNJs>



JIANGSU HOSTON MACHINE TOOLS CO., LTD.

江苏豪士敦机械设备有限公司

Mob: 0086-18021995133 Tel: 0085-523-84506989

Email: sales@hoston.cc Website: www.hostonspinning.com

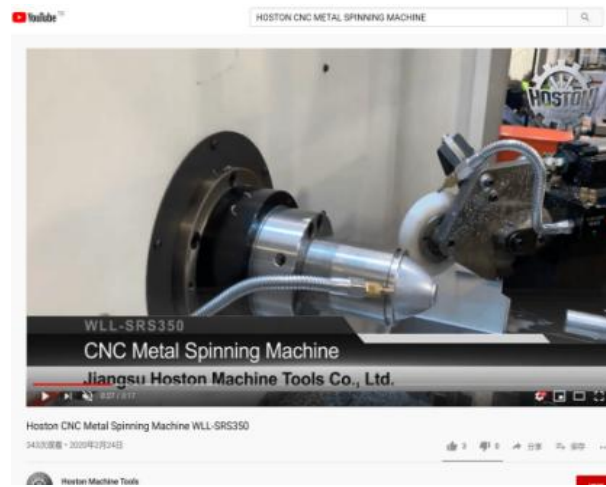

(WLL-SRS350&650 light-duty type with Manipulator)

<https://www.youtube.com/watch?v=kvVRgk7g6h0>

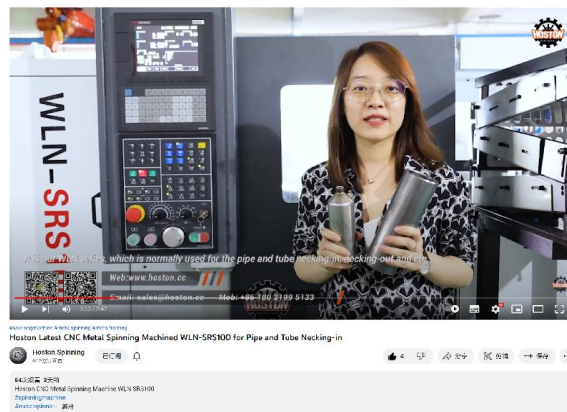

WLN-SRS100 full automatic CNC pipe & tube necking in/out series

<https://www.youtube.com/watch?v=3baFD4uAsDQ>

<https://www.youtube.com/watch?v=YAopo0SbZEU&t=11s>



(Customer's Factory Visit)

8. Machine's configuration



JIANGSU HOSTON MACHINE TOOLS CO., LTD.

江苏豪士敦机械设备有限公司

Mob: 0086-18021995133 Tel: 0085-523-84506989

Email: sales@hoston.cc Website: www.hostonspinning.com

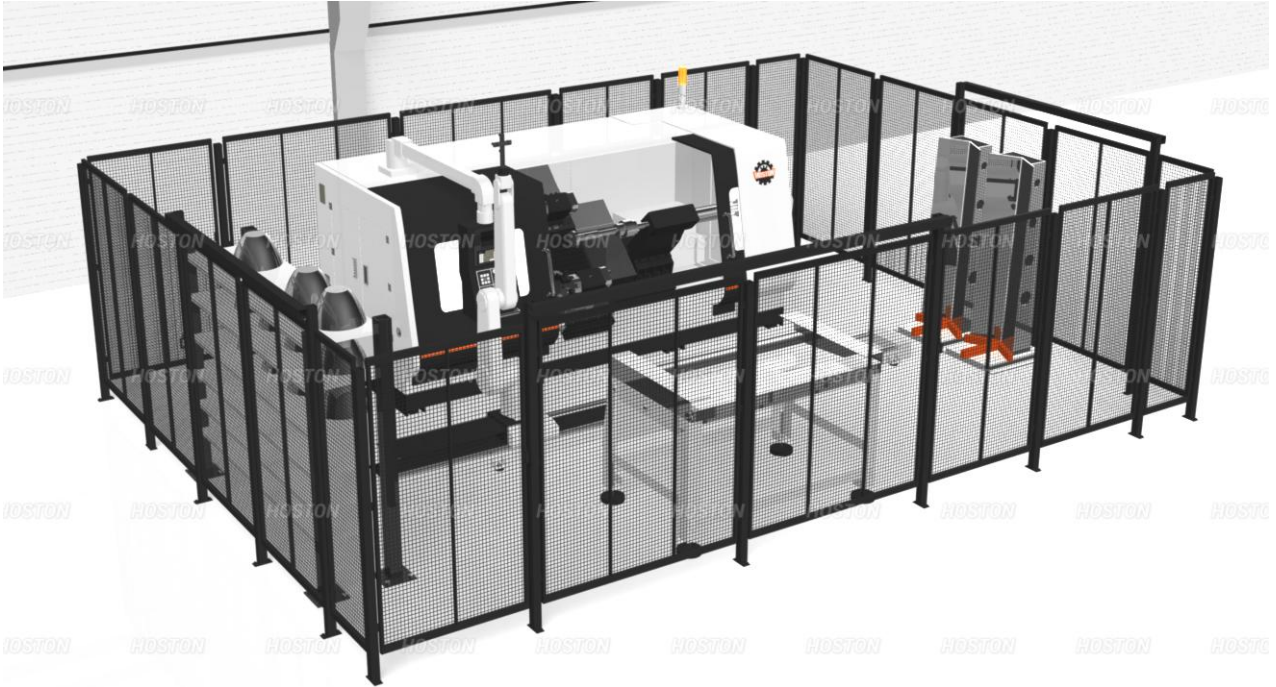

Loading scope(RB-20)



IV. Commercial items

FM:	Hoston Machine Tools CO., LTD.
RE:	CNC Metal Spinning Machine

Price Information